

(1 : 40)

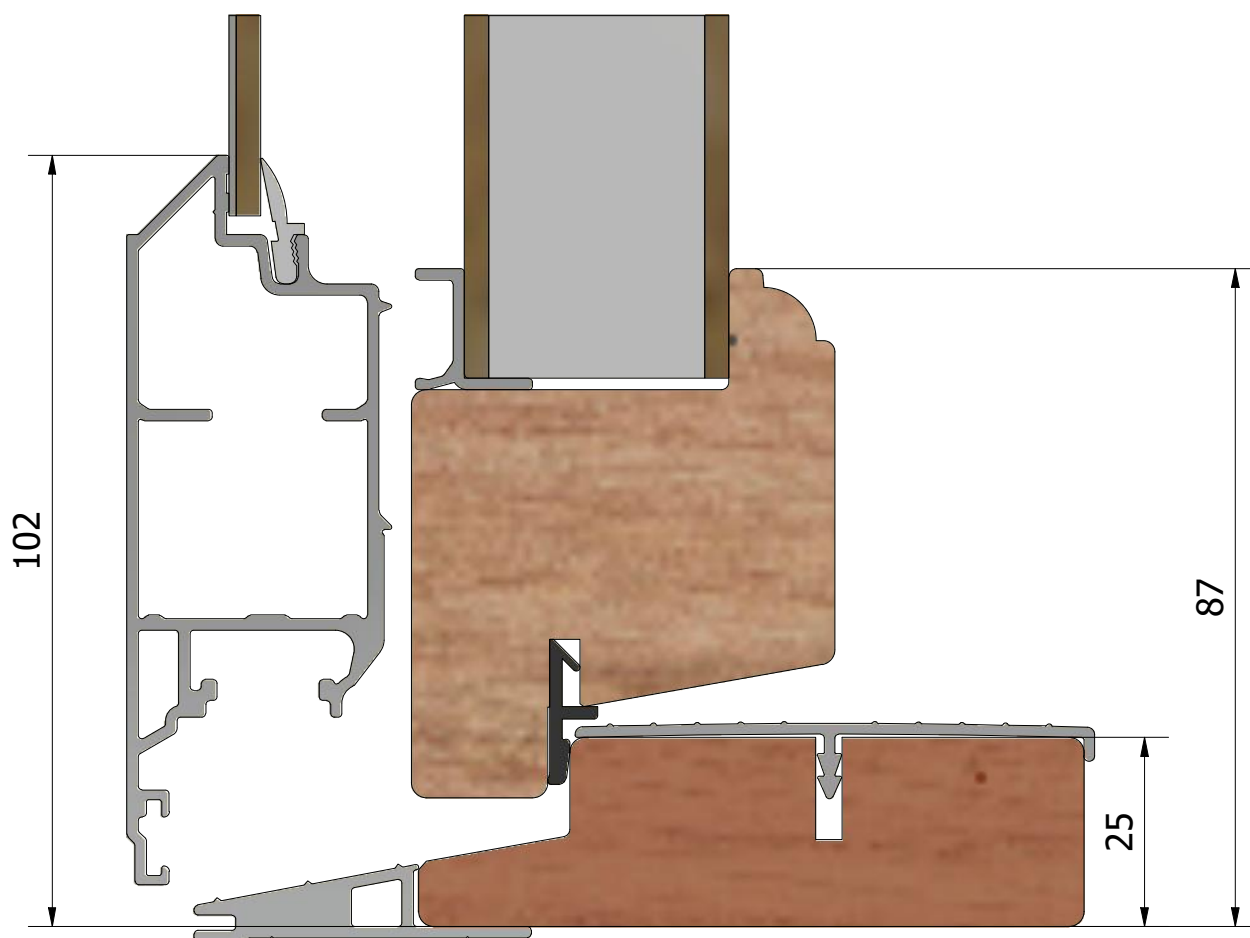

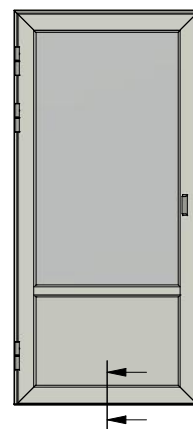

(1 : 40)

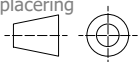
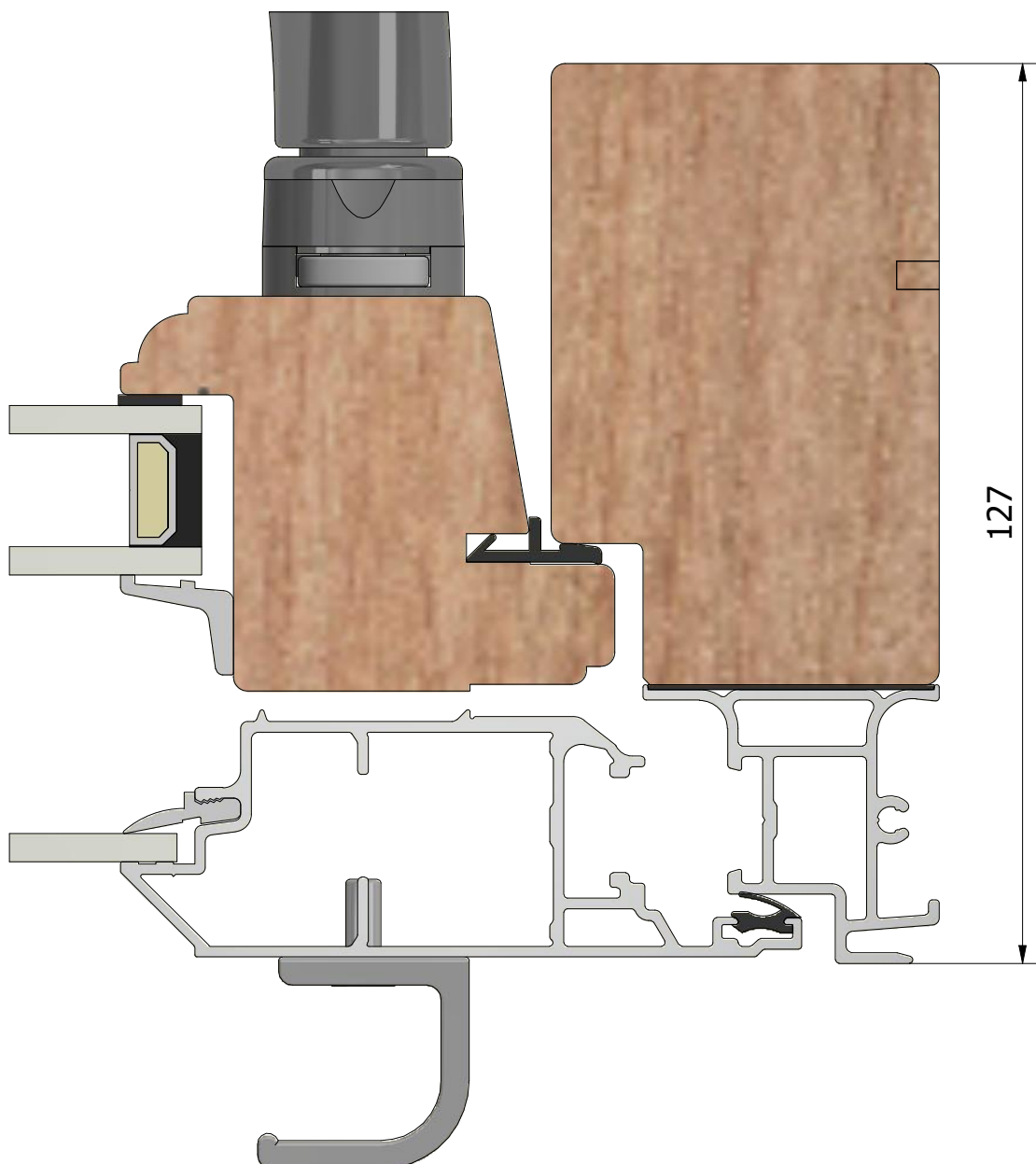
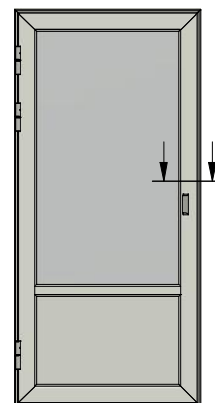

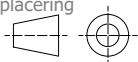

(1 : 40)

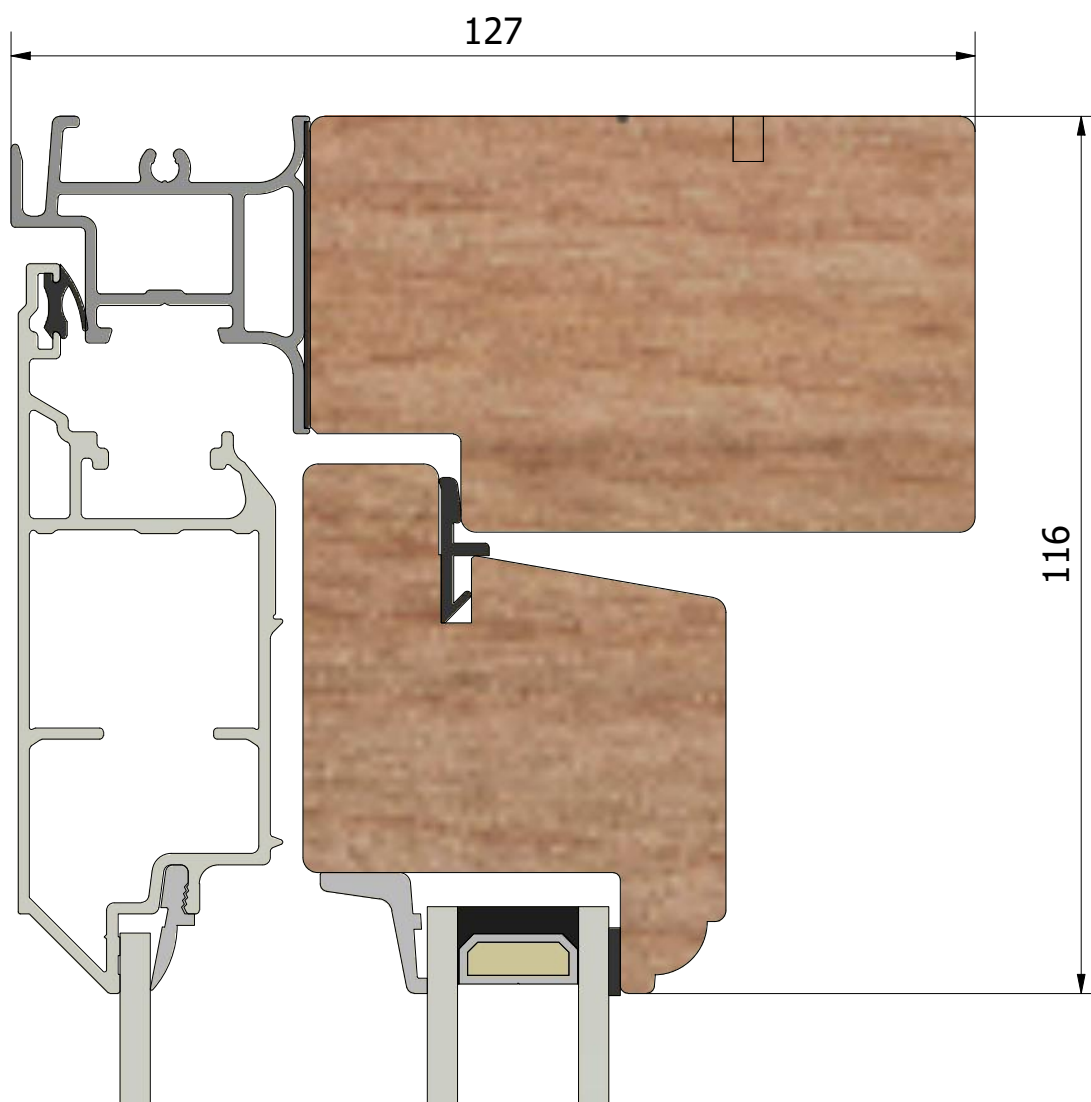
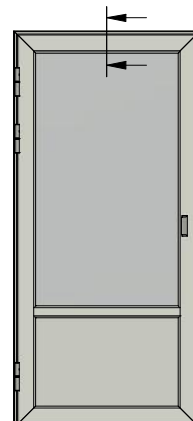

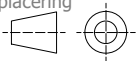

(1 : 40)

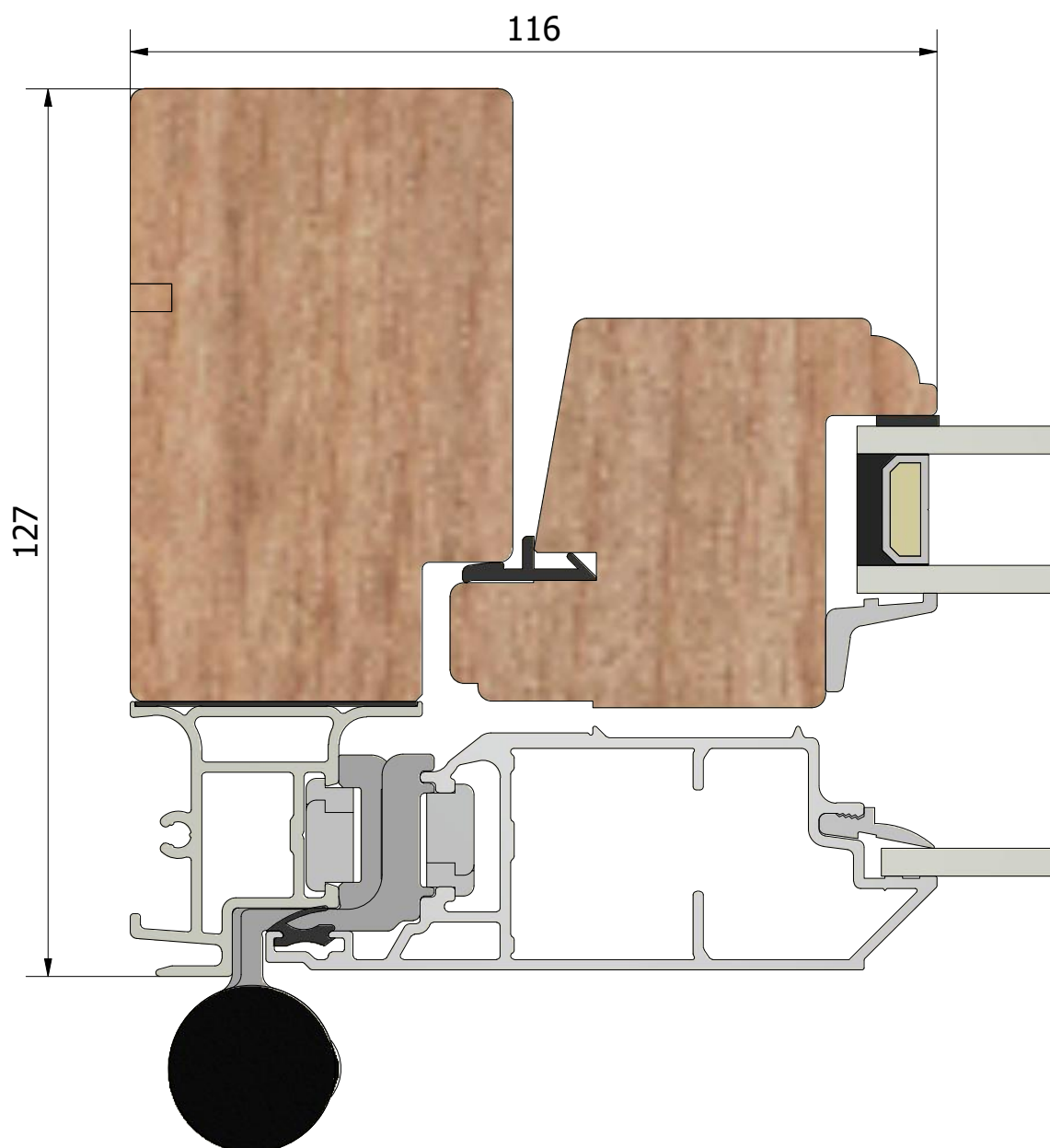
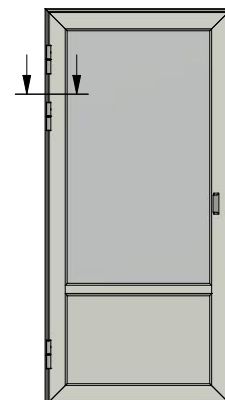

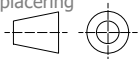

(1 : 40)

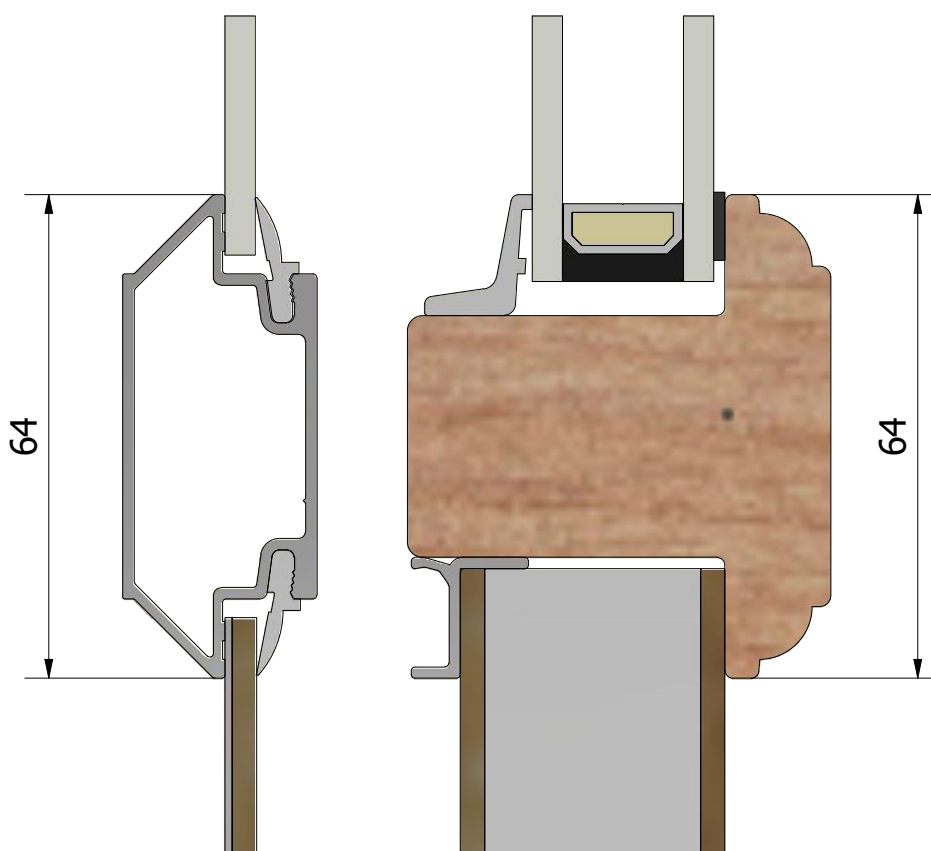
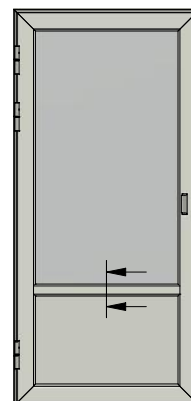

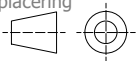

(1 : 40)

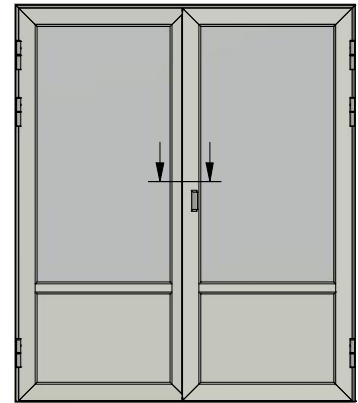

163

