

Ritn. storlek A4	Skala 1 : 1	Sida 1	Beskrivning Stil inåtgående kipp-drehfönster 3+1
----------------------------	-----------------------	------------------	--

Generell tolerans
SS-ISO 2768-1, mProduktnamn
LKF954.2Skapad av
ThomasNSkapad datum
2021-04-22

Revisionsnr. Revisionsbeskrivning

(1 : 40)**Dräneringshål**

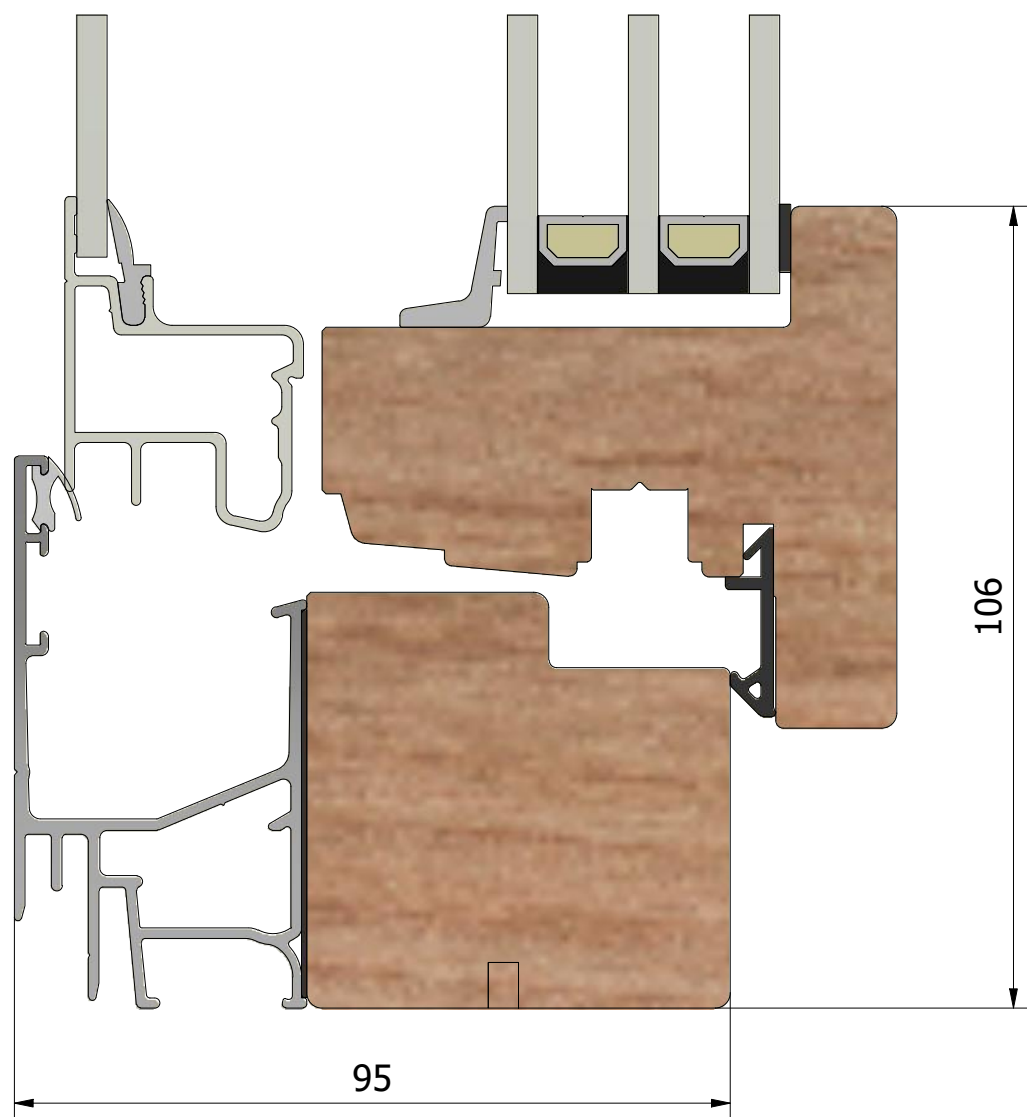
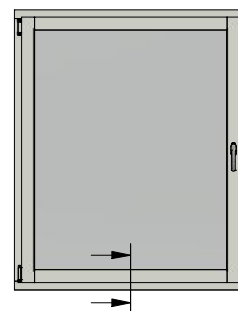
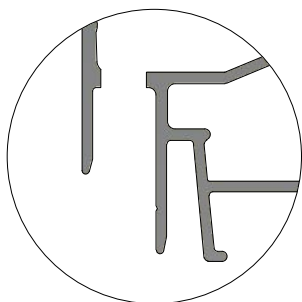
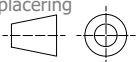

(1 : 40)

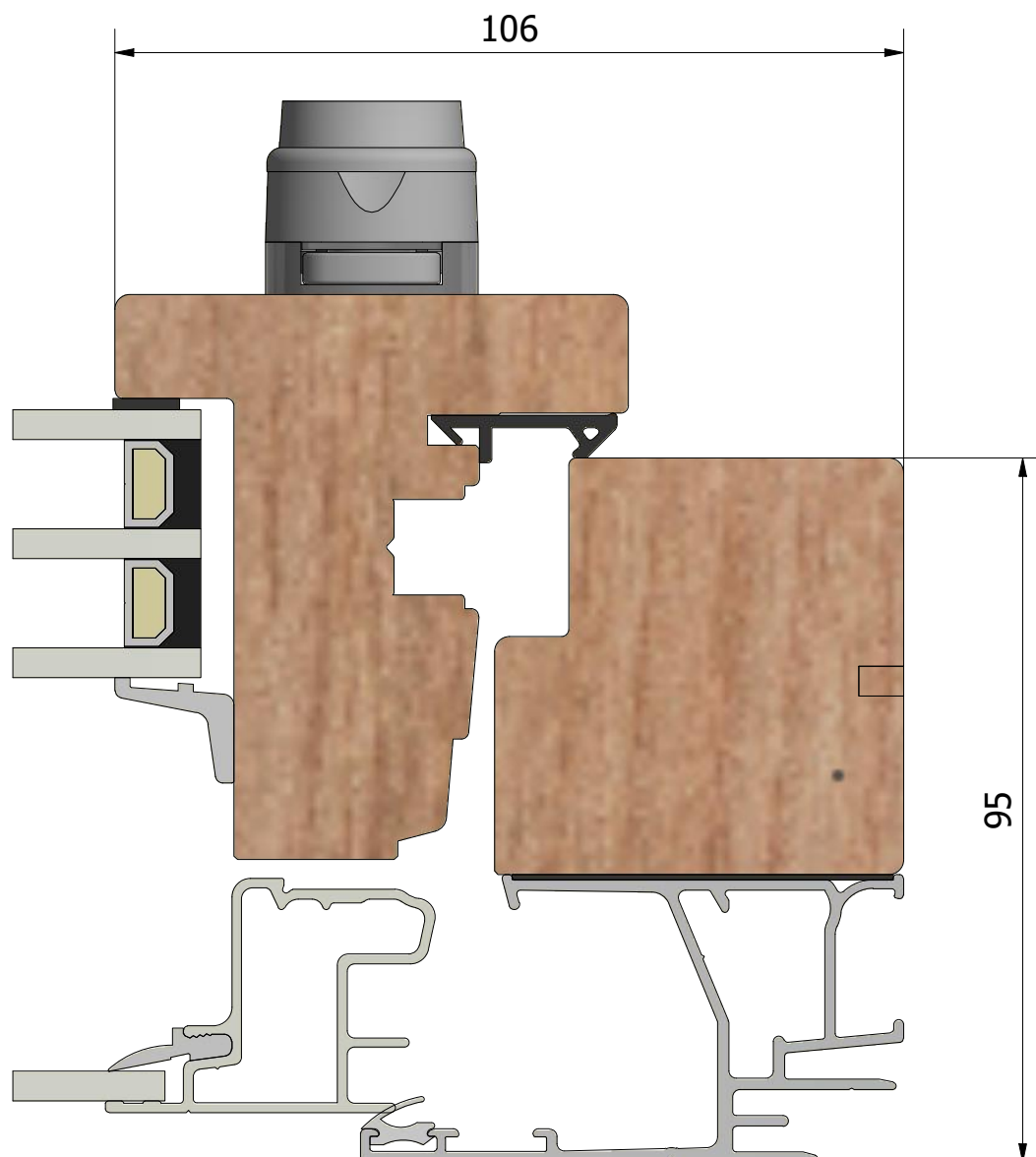
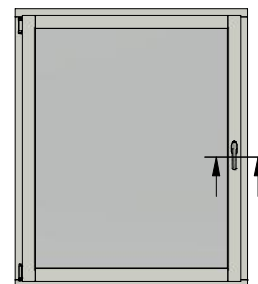

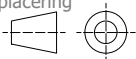

(1 : 40)

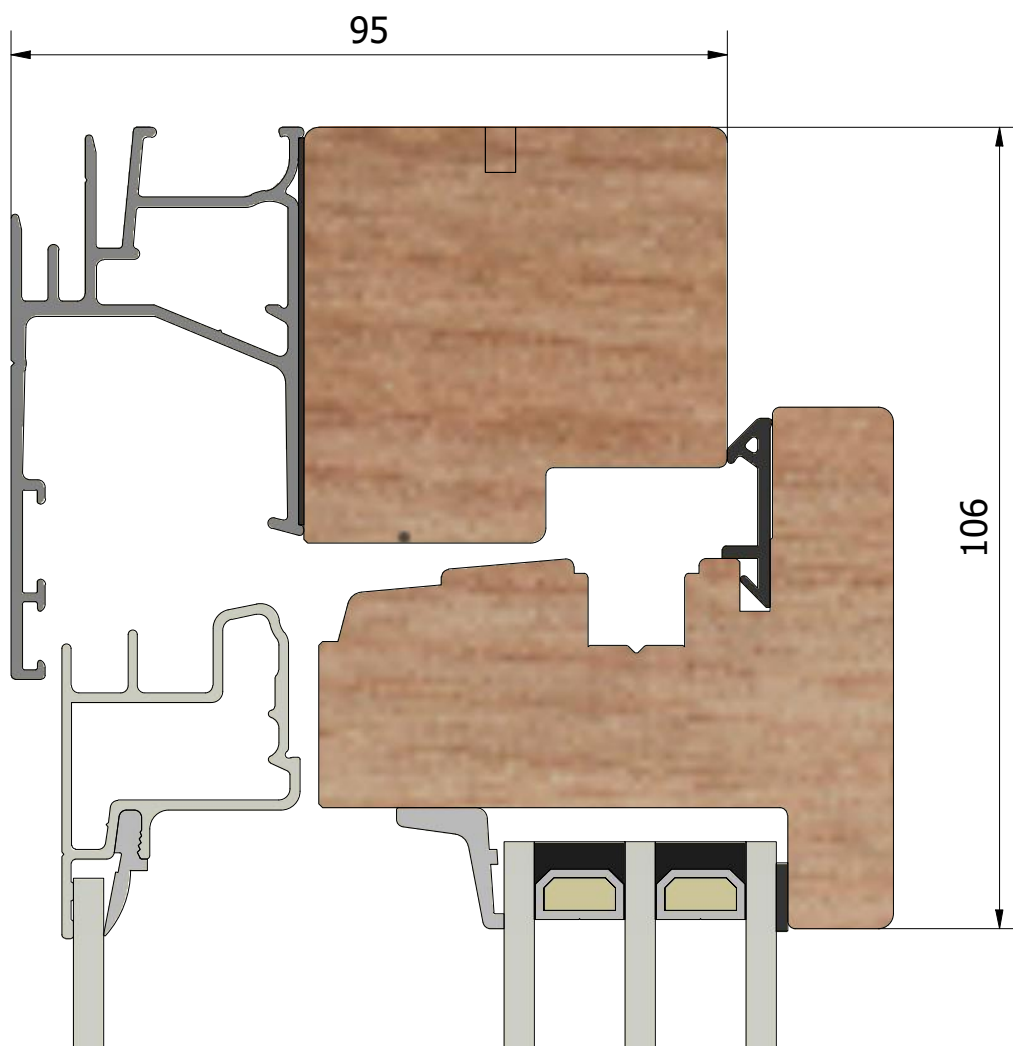
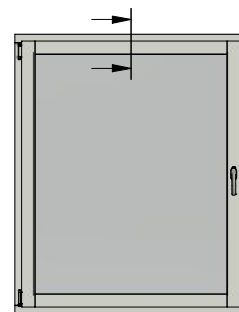

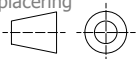
Ritn. storlek
A4Skala
1 : 1Sida
4

Beskrivning

Stil inåtgående kipp-drehfönster 3+1

Generell tolerans

SS-ISO 2768-1, m

Produktnamn

LKF954.2

Skapad av

ThomasN

Skapad datum

2021-04-22

Revisionsnr.

Revisionsbeskrivning

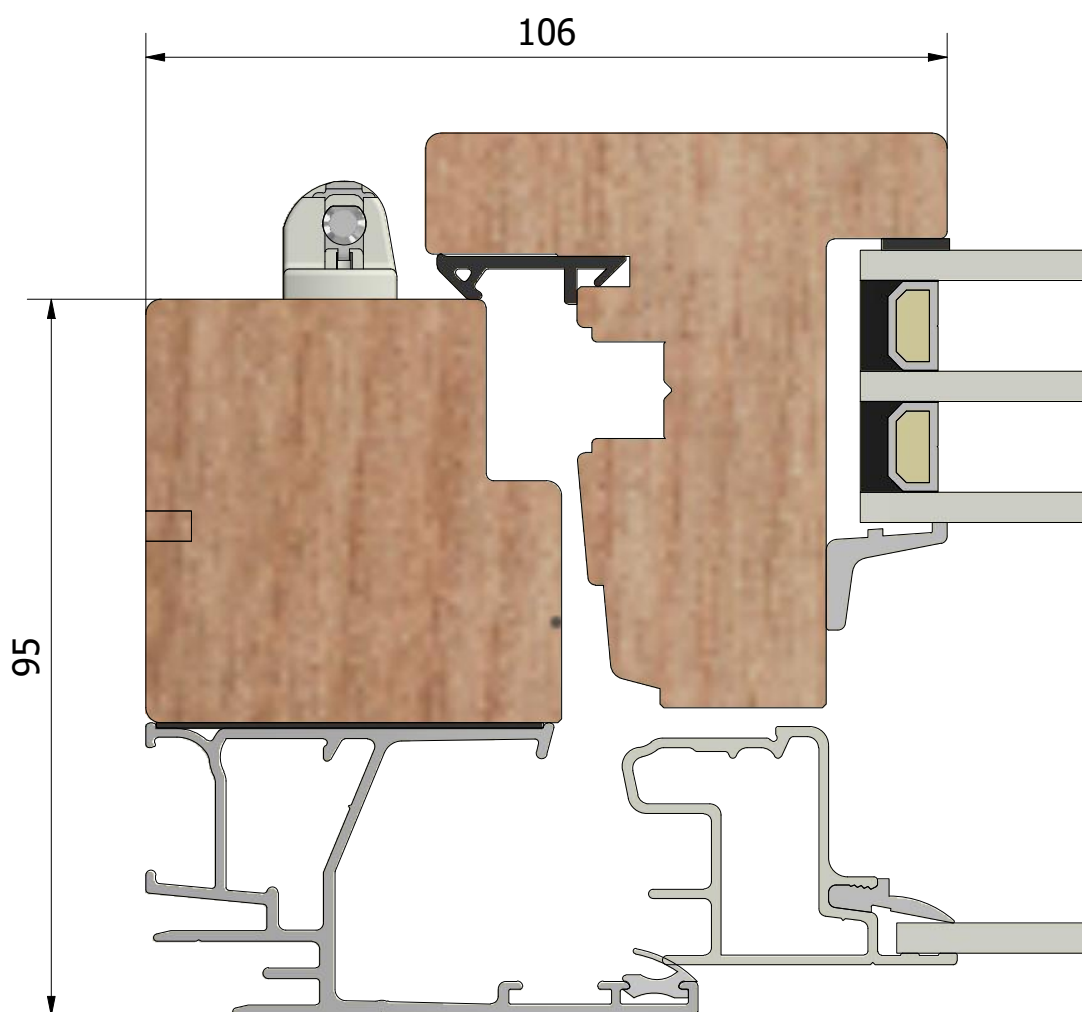
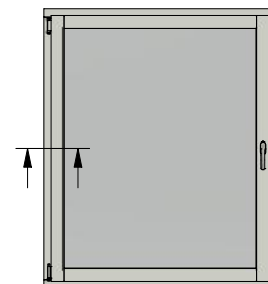
(1 : 40)

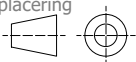

(1 : 40)

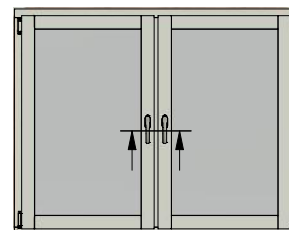

159

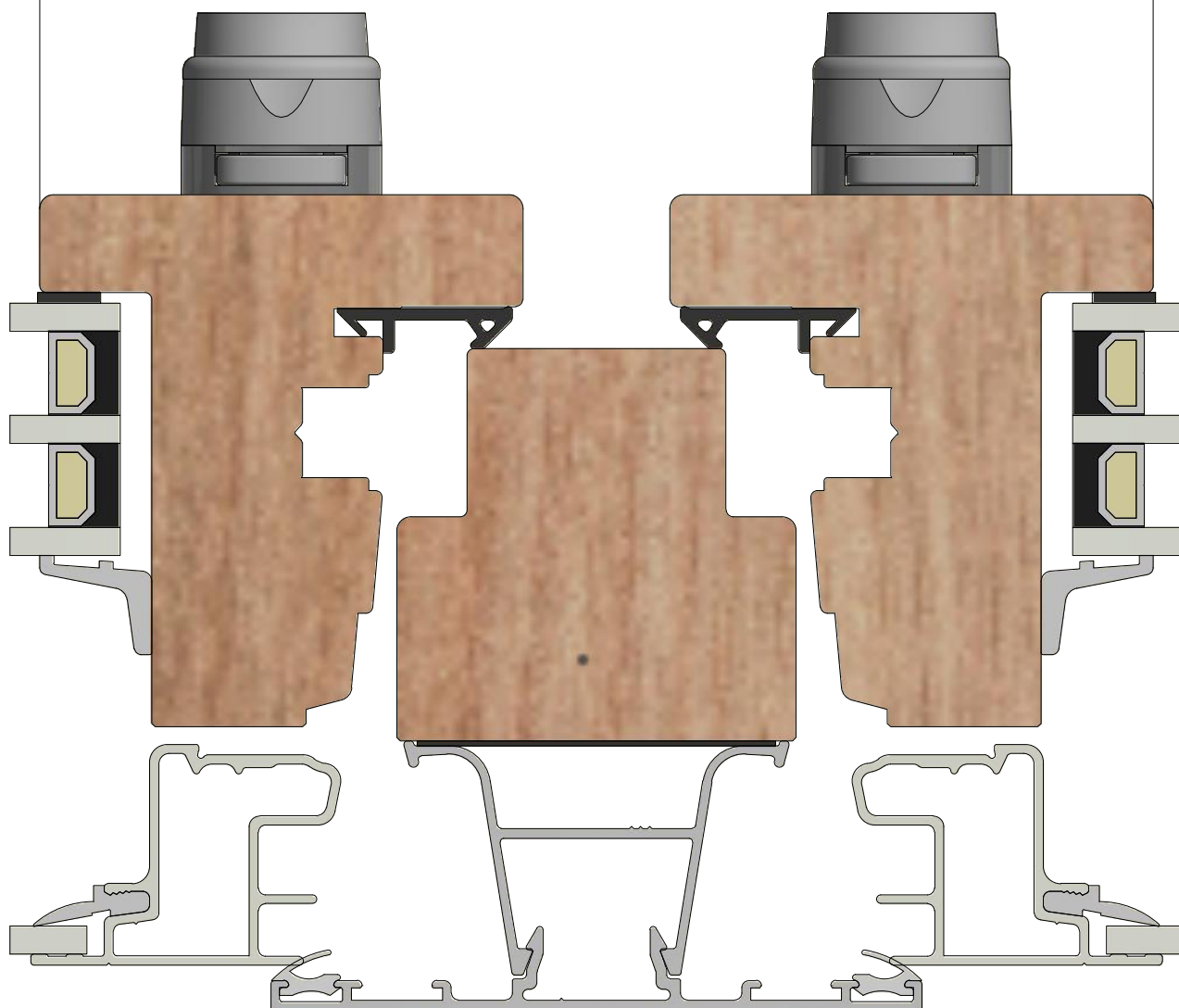

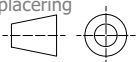

(1 : 40)

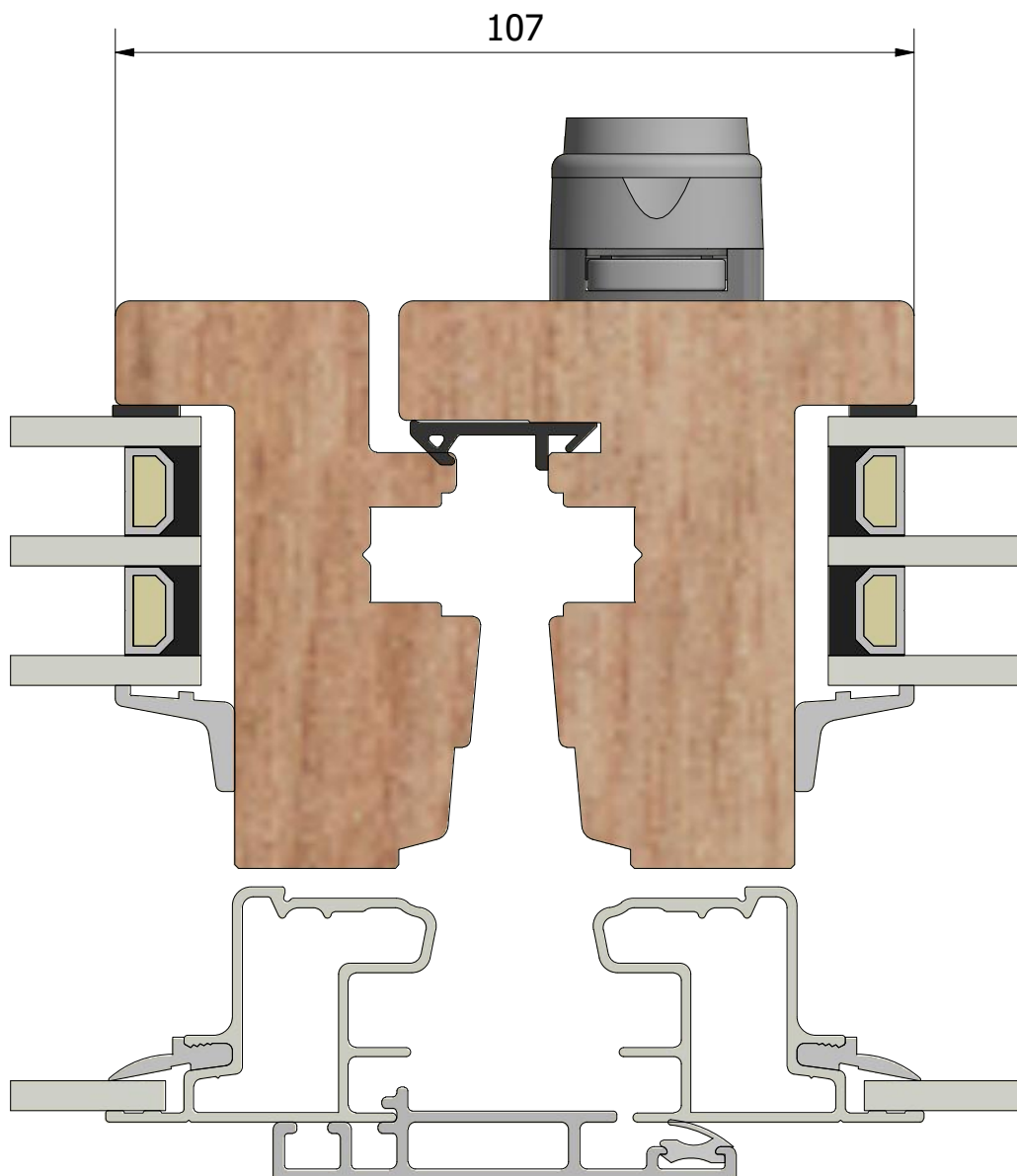
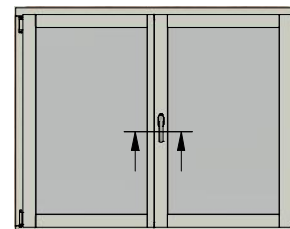

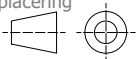
Ritn. storlek
A4Skala
1 : 1Sida
7

Beskrivning

Stil inåtgående kipp-drehfönster 3+1, fastkarm 3-glas

Generell tolerans

SS-ISO 2768-1, m

Produktnamn

LKF954.2, LFI953.2

Skapad av

ThomasN

Skapad datum

2021-04-22

Revisionsnr.

Revisionsbeskrivning

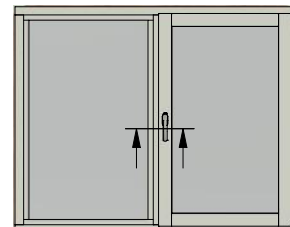
(1 : 40)

126

